

# victory

ready to provide more flexibility and efficiency



**ENGEL**  
be the first



**25** years tie-bar-less  
**10,000** satisfied customers  
**70,000** machines on the market

## Machine system **with space**

Less production space and lower investment costs, especially for:

- moulds with multiple-cavities
- large cavities with small projected area
- ENGEL foammelt applications
- multi-component applications

### **Use the freedom to fulfill all your needs**

The tie-bar-less victory is a proven all-rounder among injection moulding machines. Its flexible modular system makes it extremely well suited for producing many different technically complex and thick-walled parts of the highest quality. Its tie-bar-less technology, which has proven itself for over 25 years, enables you to use a relatively small injection moulding machine even for large moulds. You therefore only need to invest in the clamping force you actually require – and have more room for new ideas.

## ENGEL victory **more freedom for your production**

The victory is the ideal basic machine for many different applications and a wide range of technologies, because with no tie-bars, it offers advantages in precisely those areas many would never think of. Its excellent platen parallelism provides particularly even distribution of the clamping force and the best possible protection for the mould. This also guarantees consistent part quality even in multiple-cavity applications. In addition, the victory impresses with very low energy consumption levels which are due to its efficient drive technology. This is not only good for the environment, but also for your budget.

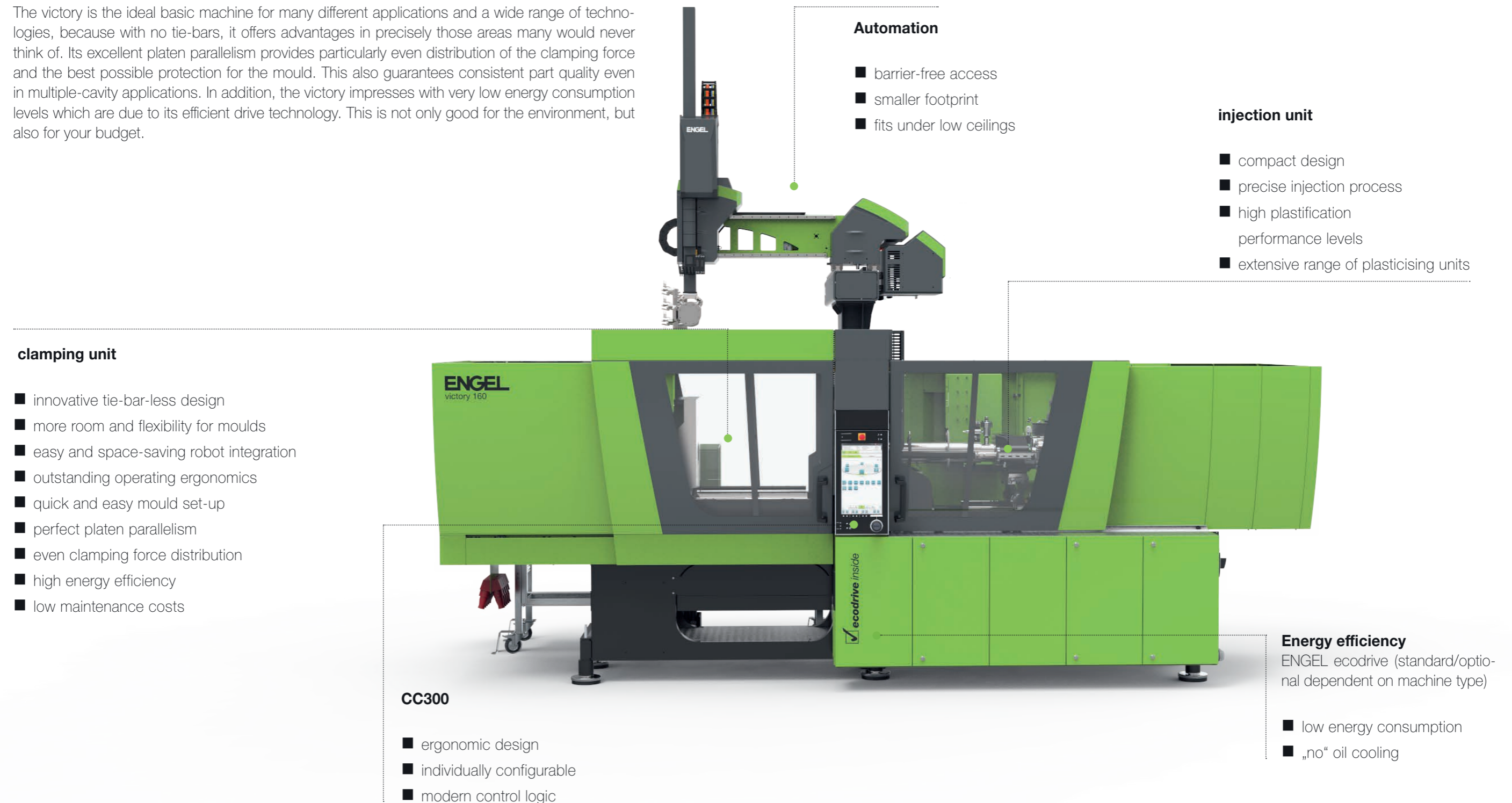

### clamping unit

- innovative tie-bar-less design
- more room and flexibility for moulds
- easy and space-saving robot integration
- outstanding operating ergonomics
- quick and easy mould set-up
- perfect platen parallelism
- even clamping force distribution
- high energy efficiency
- low maintenance costs

### Automation

- barrier-free access
- smaller footprint
- fits under low ceilings

### injection unit

- compact design
- precise injection process
- high plastification performance levels
- extensive range of plasticising units

### CC300

- ergonomic design
- individually configurable
- modern control logic

### Energy efficiency

ENGEL ecodrive (standard/optional dependent on machine type)

- low energy consumption
- „no“ oil cooling

## ENGEL victory **advantages**

### **Large mould area**

The advantages of the barrier-free mould area are particularly noticeable when large moulds or bulky core pulls are being used. The generous dimensions of the mould mounting platens can be used right up to the edges – and often beyond.

### **Excellent energy efficiency**

The low friction levels, closing pressure lock-in and ENGEL ecodrive system make it possible to match the energy efficiency levels achieved by all-electric machines in the production of technically complex parts.

### **Outstanding availability**

More productivity thanks to short set-up times: the lack of tie bars means moulds can be changed quickly even when they are large and bulky. The low-friction robust design also keeps the maintenance costs for the machine extremely low.

### **Ideal for automation**

Integration made easy: benefit from faster part removal, a smaller machine footprint and the lower machine height made possible by horizontal access to the mould area.

### **Optimal mould protection**

The central Flex-Link element enables the moving mould mounting platen to follow the mould precisely while the clamping force is building up: the platen lifts itself from the linear bearings, automatically aligns the platen parallelism to the current mould parallelism and thus distributes the clamping force evenly across the entire mould cross section. As a result, transverse forces are prevented, prolonging the service life of the mould.

### **Consistent part quality**

The hydraulic injection units boast outstanding injection process control – the standard clamped injection piston responds extremely quickly and sensitively to any changes to the control parameters. In addition, the patented force divider provides optimal distribution of the clamping force and therefore uniform compression across the entire mould cross section. Regardless of whether a part is moulded at the centre or the edge of the mould, the victory ensures consistent quality, especially when the mould contains a high number of cavities.

### **Perfect clean room compatibility**

The tie-bar-less mould area reduces air turbulence and the low-emission drive technology without fans (the ENGEL ecodrive system is optional) making the victory perfectly suited to clean room production.

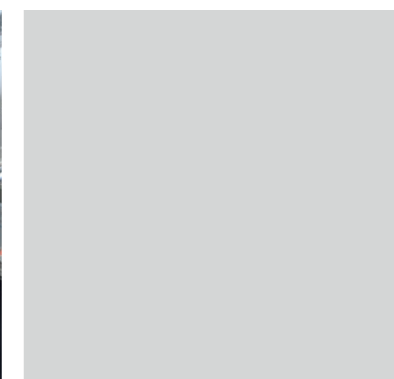
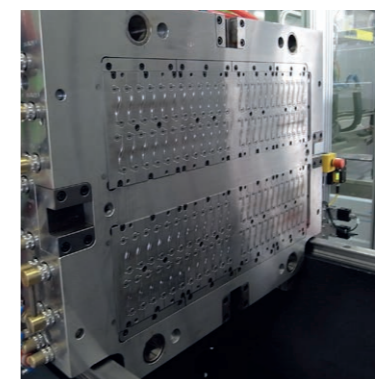
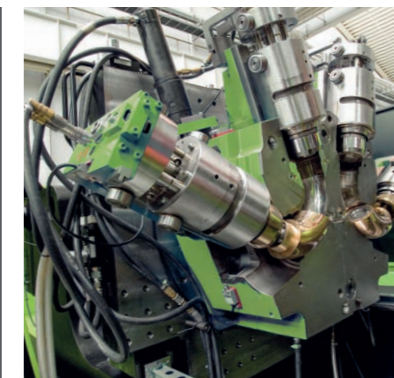
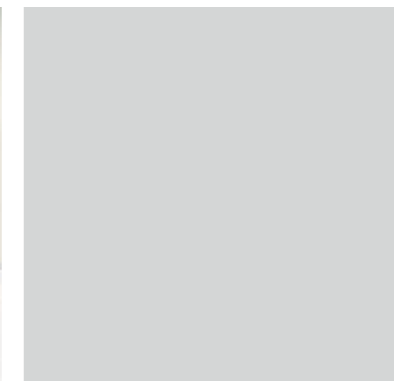

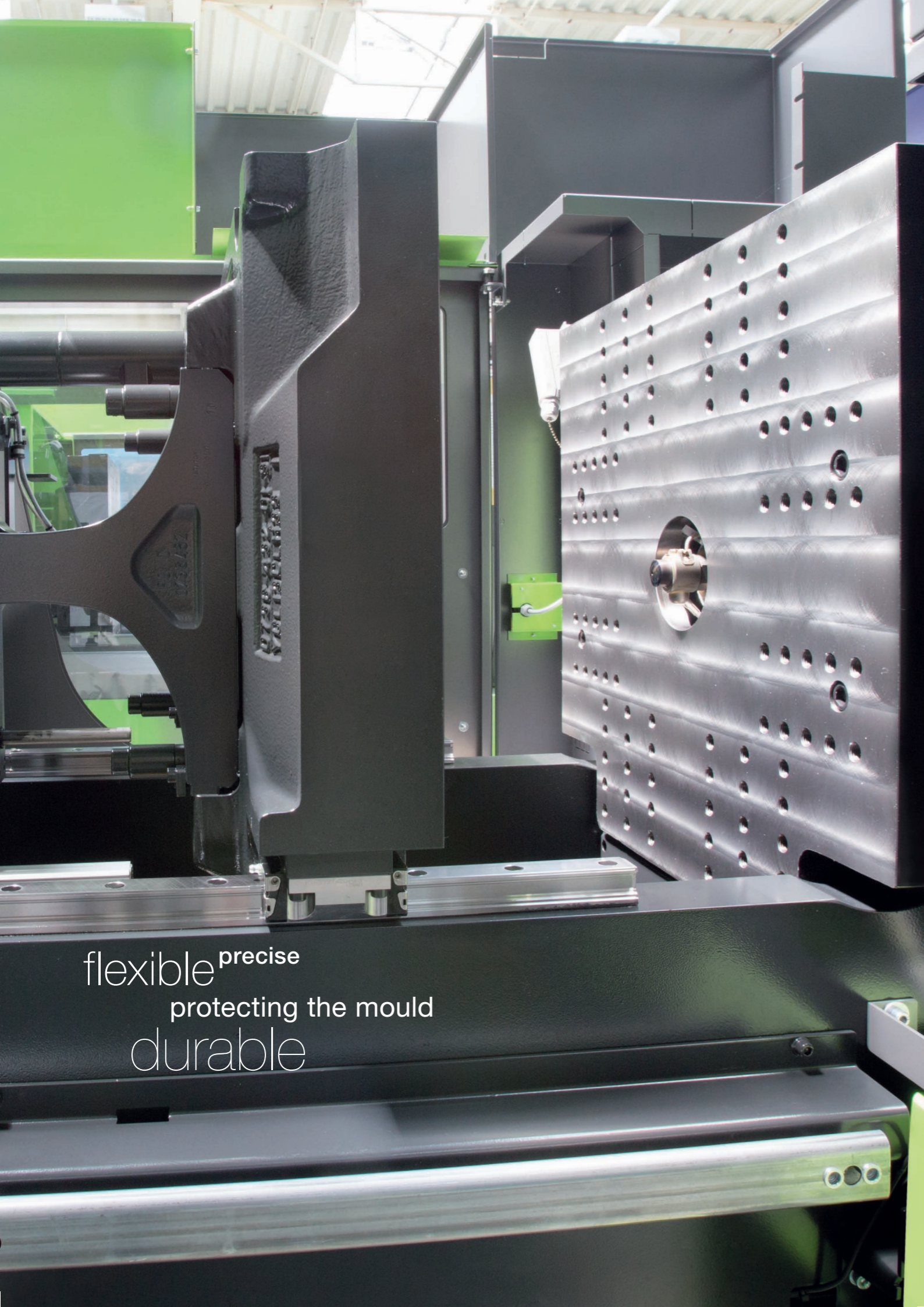

## ENGEL victory clamping unit

### Precise clamp system

Each tie-bar-less clamping unit is aligned precisely prior to delivery using the highly sensitive platen parallelism adjustment mechanism. This guarantees a long service life for both the machine and the moulds used. As the clamping force increases, the platen parallelism of the ENGEL victory automatically adapts to the mould parallelism. This unique advantage is realised through the innovative Flex-Link system.

### Heavy moulds

Heavy moulds are no problem for the tie-bar-less clamping unit. The high-precision platen parallelism is adequately ensured by the preloaded tension of the Flex-Link system and support provided by the solid C frame. And thanks to the use of additional bearings to support the moving mould half, the mould weight can be increased almost without limits.

### Ergonomic operation

The tie-bar-less technology makes working in the mould area easy and comfortable – the operator can carry out all important tasks such as cleaning and spraying without having to stoop down and reach between tie-bars. And this is possible from any angle.

### Smaller machines

The smaller machine size allows up to 10% more parts to be produced on the same floorspace: the large and freely accessible mould area means that an ENGEL victory machine with a considerably lower maximum clamping force can be used than would normally be necessary to use a mould of the same size on a tie-bar machine. This is a significant advantage, especially in multiple-cavity applications, because then the required clamping force is usually very low compared to the mould size. The smaller dimensions also provide an extra bonus: there is more room for peripheral equipment or additional production cells.

### Outstanding energy efficiency

The tie-bar-less principle provides significant advantages when it comes to resource-friendly production: in particular, the precise guide system with ball-bearings, the absence of tie-bar friction and the clamp pressure lock-in significantly increase energy efficiency. And if you add ENGEL's optional ecodrive system, you will save the maximum amount of energy possible with your ENGEL victory.

flexible precise  
protecting the mould  
durable

## The **tie-bar-less** principle - best conditions for your mould

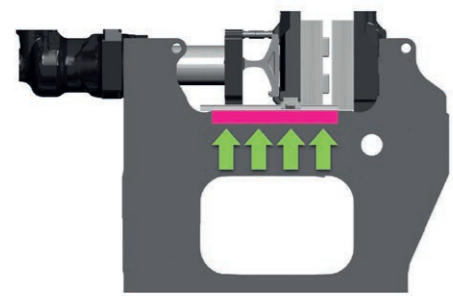

### Optimal support for mould weight

One special feature of tie-bar-less injection moulding machines is their solid frame. The clamping unit is given optimal support and suffers no deflection even with very heavy moulds. Thanks to additional linear bearings available for the moving mould half, the mould weight can be increased almost without limit.

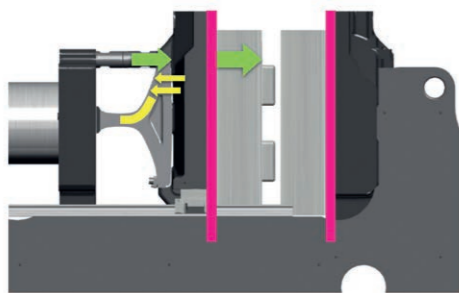

### Exact platen parallelism

Each tie-bar-less clamping unit is aligned precisely prior to delivery using the highly sensitive platen parallelism adjustment mechanism. ENGEL's parallelism tolerances are significantly lower than those of the EUROMAP norm. As the patented force dividers are preloaded, the platen parallelism remains constant even when the mould is mounted.

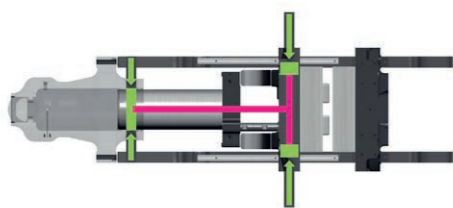

### Perfect guidance for the moving mould mounting platens

No turning and no tilting: thanks to three-point guidance – two precise linear bearings and the central clamping piston – the moving mounting platen retains its alignment even while the mould is opening and closing.

## Correct mounting matters!

Whether your machine has tie-bars or not, please make sure that the two halves of the mould are aligned perfectly at all times. Even after they have been mounted, the alignment can still be changed by processes such as mould temperature changes. If a deviation in the alignment remains unnoticed, it can lead to parting line problems and/or increased mould wear.

### Dynamics of the stationary mould mounting platen

In contrast to other machine designs, the stationary mould mounting platen is not connected with the frame at the bottom end, but at its back. This way it absorbs the machine's vibrations in a symmetric manner and remains parallel to the moving platen even during acceleration and deceleration.

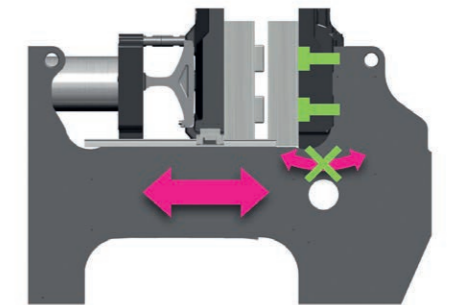

### Optimal mould protection

The flexible central elements (Flex-Links) make it possible for the platen parallelism to adapt perfectly to the parallelism of the mould. In this process, the moving platen is lifted out of its bearings. In this way, when the mould is mounted correctly, a constant compression is achieved, completely preventing any transverse forces and thus increasing the life span of the mould.

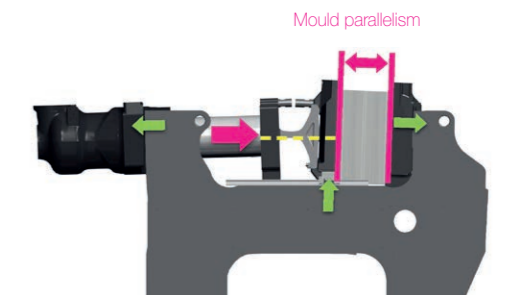

### Even clamping force distribution

No matter whether the cavities are centred or located on the edge of the mould mounting platen, they all are subject to exactly the same level of clamping force. The patented force dividers make sure that the clamping force is distributed evenly over the entire mould mounting platen. This guarantees a consistently high part quality even in multiple-cavity moulds.

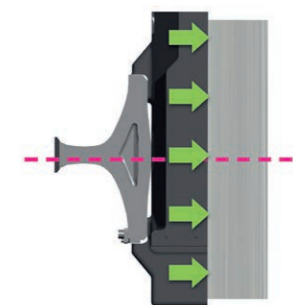

# ENGEL victory injection unit

## Excellent injection process control

The hydraulic ENGEL injection units are distinguished by their excellent injection process control. Compared to conventional injection controllers, the 'clamped system' on injection pistons included in the standard version with the highly sensitive electronic controllers reacts extremely quickly to disturbing influences and any process-related changes. This guarantees injection moulded parts of excellent quality and a high degree of reproduction accuracy. In order to achieve a high degree of process consistency even when changes occur in ambient conditions or in raw materials, the **iQ weight control** software helps by automatically recognising deviations from target values and compensating for them in the same shot (optional).

## ■ ENGEL iQ weight control.

### Smart online process control. An intelligent option.

ENGEL's newly developed iQ weight control software automatically detects viscosity fluctuations and compensates for them in the same shot. The results: substantially improved reproducibility of the process and part weight. Or to put this another way: more good parts, less rejects and thus higher productivity!

Even if the ambient conditions change: the quality of your moulded parts remains consistently high. Shot for shot.

## Flexible injection performance

The ENGEL victory's injection performance is designed for the production of complex technical parts. If a higher injection performance is needed, for example for very thin-walled parts, the performance can be increased using optional hydraulic accumulators. The injection process is then controlled by valves.

## Plasticising units for any application

A range of barrel and screw configurations is available to configure the plasticising unit specifically for the respective application. The plasticising unit is pressed against the mould torque-free, the required force for this can be adjusted via the machine control. The thermal concept of the plasticising unit ensures precise controllability on the one hand and low energy consumption of the heater on the other hand, as well as a reduced consumption of cooling water in the intake area (dependent on machine size). With the selection of appropriate hydraulic variants, an increase of plasticising performance and/or the plasticising process can be controlled simultaneously with the mould movements.

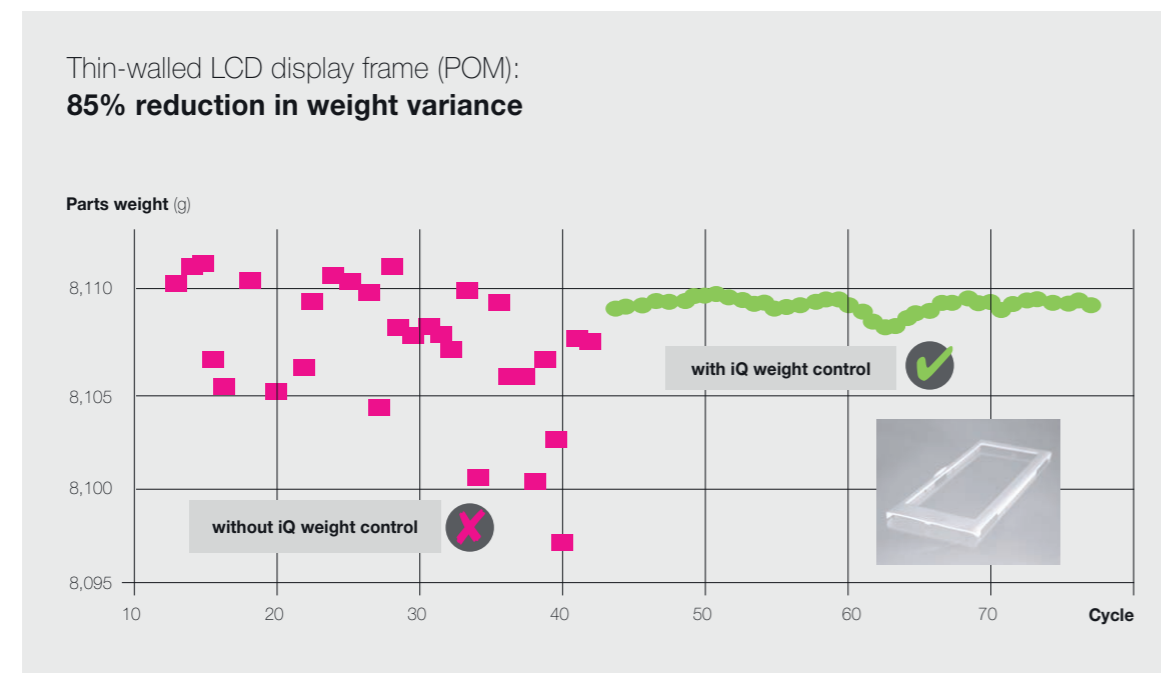

efficient compact  
durable

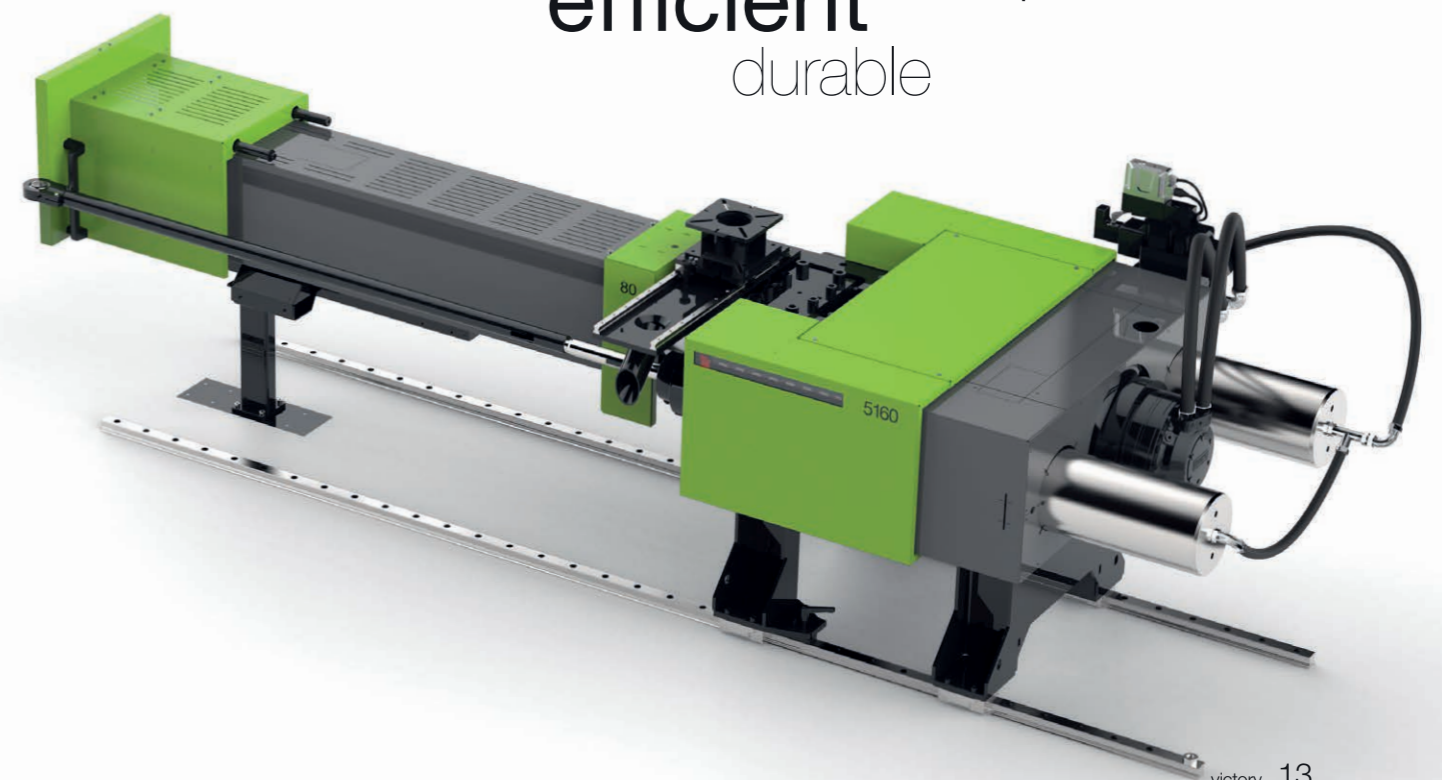



fast  
energy-efficient  
reproducible

## ENGEL victory drive technology

Place your trust in more flexibility thanks to modular hydraulic variations. It does not matter whether it is for parts easy to demould, for complex moulds with simultaneous movements or for applications requiring high injection performance: ENGEL has been relying on highly efficient hydraulic drive units to meet any requirement profile for many years. Thus we already set new standards in energy efficiency and process control more than 20 years ago when we replaced PQ hydraulics with EHV hydraulics. The ENGEL ecodrive combines the benefits of hydraulics and servo drive technology. This once again significantly increases control accuracy and energy efficiency.

- single pump system for sequential movements
- dual pump systems for simultaneous movements (ejector, core pull, nozzle or plastification movements)
- more powerful drives for increased injection and plasticising performance
- accumulators for extremely high injection performance
- ENGEL ecodrive for the highest energy efficiency (dependent on the injection unit in standard/optional)

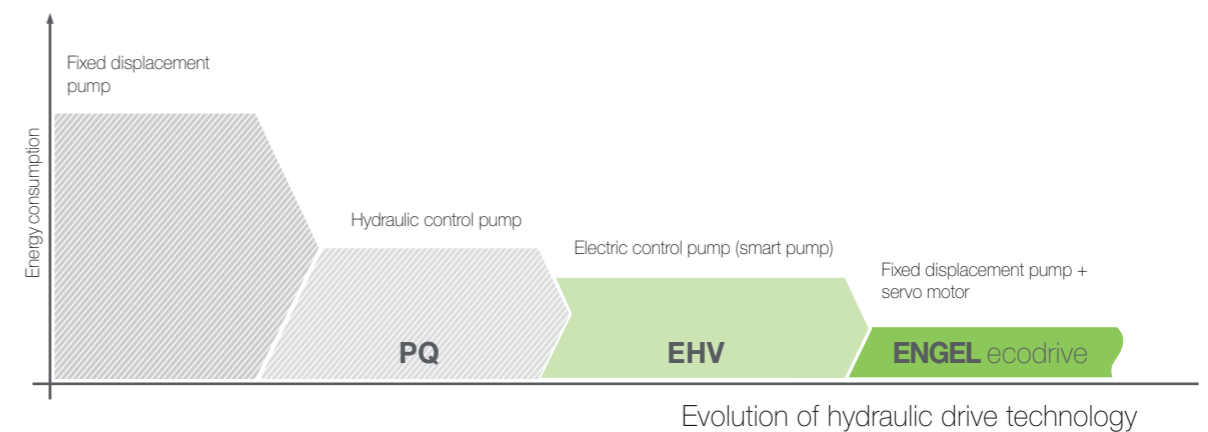

### Closing pressure **lock-in**

All movements and pressures for the individual machine movements are, of course, regulated hydraulically. But where it makes sense – when holding the clamping force and nozzle contact force – the required pressure is maintained hydraulically, which reduces the holding energy to zero. As the cycle time increases, the energy savings grow to a substantial level.



# ENGEL ecodrive **the revolutionary hydraulic concept**

## ■ **low energy consumption**

Matches the level achieved by all-electric machines when complex technical parts are being produced

## ■ **„no“ oil cooling**

Reduced investment costs and less energy consumed for cooling water

## ■ **hydraulics on board**

High energy efficiency levels even in the case of moulds with hydraulic core pulls

## ■ **ideal for clean room applications**

No air turbulence and low thermal emissions

## ■ **"silent" machine**

Pleasant working conditions and extremely low noise levels

## ■ **low maintenance costs**

Robust fixed displacement pumps with very long lifespans

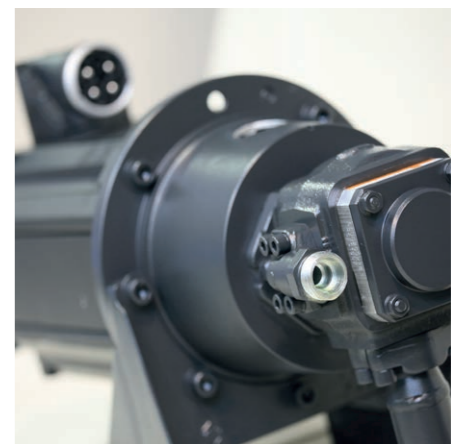
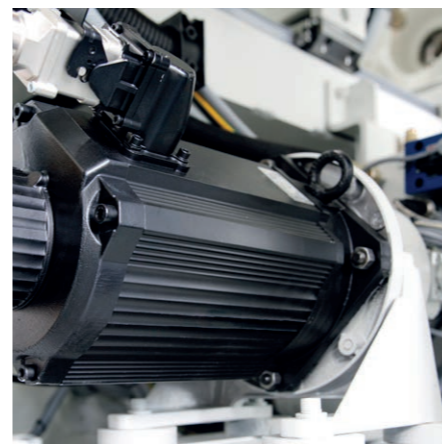

**ecodrive** inside

## **efficient, clean, durable**

Uses up to 70% less energy compared to conventional hydraulic machines

Uses up to 100% less cooling water to cool the oil

**Cooling water consumption is an indicator of the energy efficiency of hydraulic machines.**

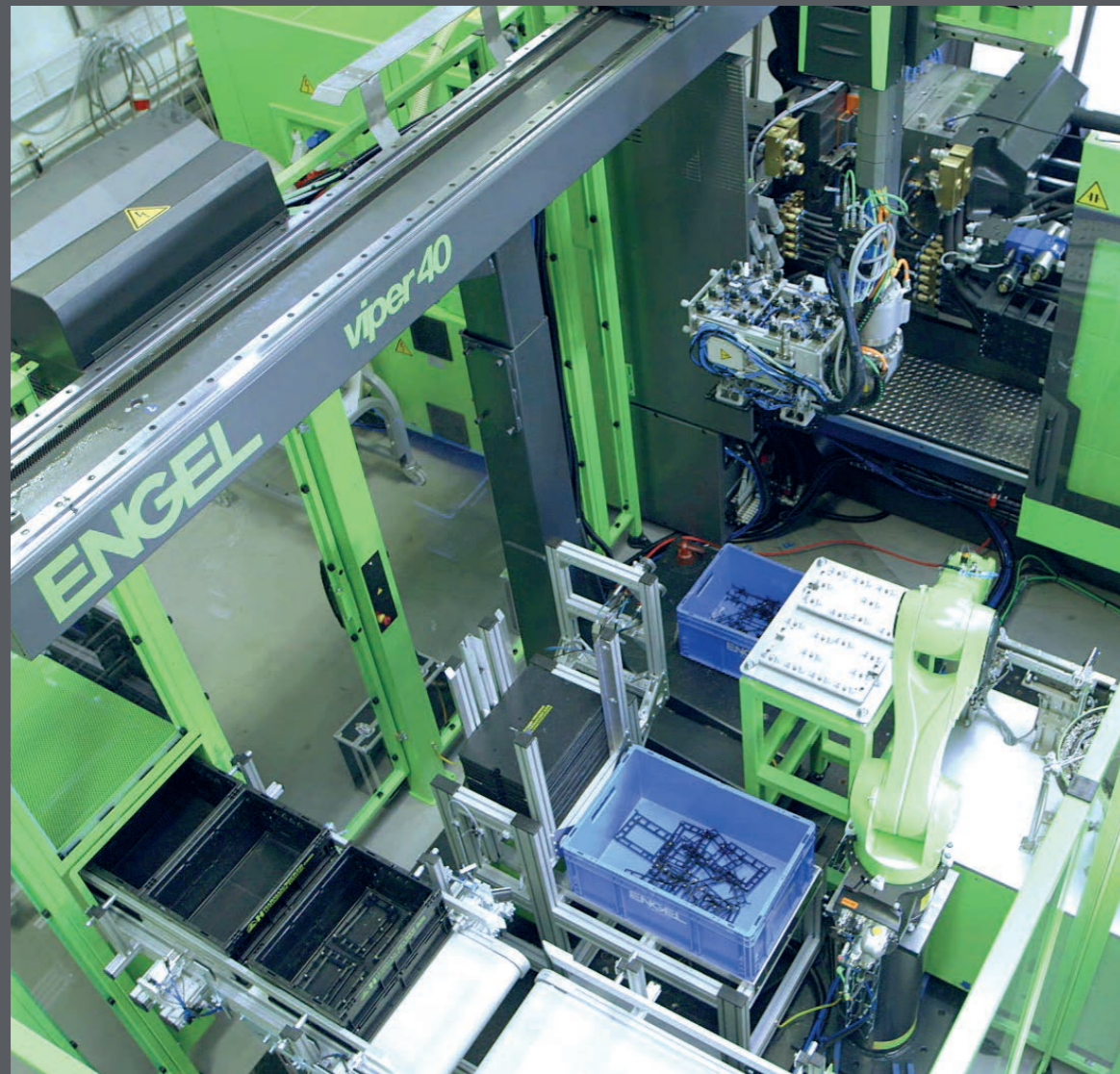

**The injection moulding machine is in many cases only one element of the whole production cell, which is often complex. Robots and automation components perform a wide spectrum of tasks.**

They range from placing inserts in and removing parts from the mould to mounting and checking operations and to packaging finished products. The key to cost-effectiveness usually lies in the efficiency of the concept as a whole and not of the individual components by themselves. And it is precisely here that the ENGEL victory offers decisive advantages in the overall solution thanks to its tie-bar-less benefits.

## ENGEL automation

### **Smaller footprint**

Opting for a tie-bar-less injection moulding machine often means a smaller machine can be used. As a result, moulds frequently use the whole platen surface. The automation can therefore be installed closer to the mould, which saves space.

### **Lower ceiling height**

Production can take place without problems and risk of collision in low halls or beneath crane runways because the robot does not need to move out of the mould in an upward direction.

### **Shorter production cycles**

The cycle time can be shortened by the direct horizontal movements of the robot in and out of the mould area, particularly in the case of complex automation.

### **Smart robot operation**

The new wizard for the robot and integration into the machine control unit make this possible.

### **Integrated automation**

The tie-bar-less design provides ideal conditions for integrating automation into the machine. The robot movements remain within a slightly widened machine safety gate. After a short horizontal movement, it places the parts on a conveyor belt placed near the mould mounting platens. Smaller footprints, lower system heights, smaller robot sizes and the elimination of additional safety guarding for each robot secure lower investment costs and better utilisation of the production floor space.

### **Fast sprue removal**

The ENGEL victory offers optimum conditions for fast and reliable sprue take-off by the sprue picker. Sprue drop chutes are available as an option for the rear safety gate.

### **Comprehensive system competence**

ENGEL designs and delivers complete system solutions in which all the components interact in perfect harmony with each other, from the injection moulding machine and robot to other automation peripheral units. This is a guarantee for excellent part quality, stable processes and maximum productivity, regardless of whether the production task is simple or highly complex.

# ENGEL victory series



## ENGEL victory **spex**

The flexible tie-bar-less machine with perfect ergonomics

- selected models
- practical pool of options
- smart ENGEL CC300 machine control unit
- efficient hydraulic system ENGEL ecodrive (standard/optional dependent on machine type)
- excellent price/performance ratio

## ENGEL victory **tech**

The versatile tie-bar-less machine that meets every need

- extensive range of models
- extensive pool of options
- perfect for customized solutions
- smart ENGEL CC300 machine control unit
- efficient hydraulic system ENGEL ecodrive (standard/optional dependent on machine type)

## ENGEL victory **combi**

The compact tie-bar-less machine for multiple-colour applications

- additional injection units (W, V and L positions)
- plenty of room for a rotary table or index plate
- increased mould installation height
- optional rotary table (hydraulic or servo-electric)
- extensive pool of options
- perfect for customized solutions
- smart ENGEL CC300 machine control unit
- efficient hydraulic ENGEL ecodrive system  
(standard for clamping forces of 2,600 kN and upwards)



# ENGEL CC300

## Ready for smart operation of machine and robot

The CC300 relies on a simple operating concept and future-oriented process integration. This smart control unit allows to navigate both the machine and the robot of a fully integrated production unit as easily as your smartphone: the two combined directly via the injection moulding machine's innovative operating panel or each separately via the light C70 hand-held touch terminal. The ergonomic design, individual configurability and modern control logic make controlling and monitoring highly integrated automated production cells significantly simpler, safer and more user-friendly.

## Simple process adjustment

Operators can quickly and easily carry out simple adjustment tasks themselves with the ENGEL wizard.

## Variable handling

Direct, safe and continuously variable control of all movements with the e-move on the panel or via the ergonomic and light C70 hand-held touch terminal

## Higher productivity levels

Get started straight away with guaranteed perfectly synchronised movements and no previous reference run necessary.

## More safety

Perfectly optimised joint data management for both the machine and ENGEL robots

## Ergonomic design

Individually configurable, functional, attractive and robust hardware with a modified user interface

## Optimum readability

Displays with excellent contrast for all lighting conditions and at all angles

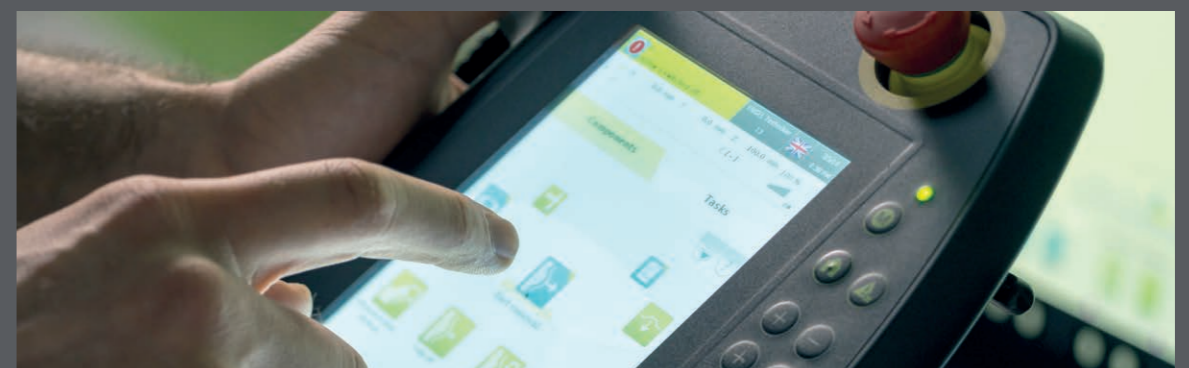

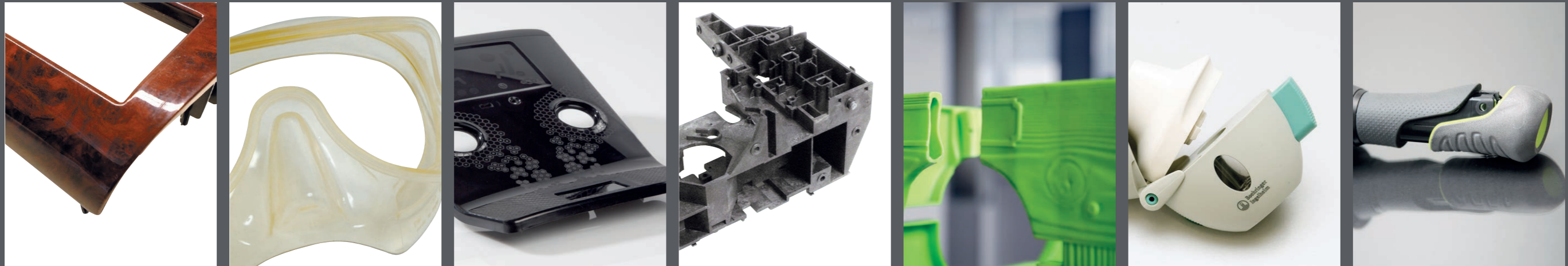

## ENGEL victory Technologies

Wherever plastics are used nowadays, the right ENGEL technology refines any raw material and adds special characteristics for the desired application. The victory tech and victory combi provide the perfect basis for the many options available here. Utilise our expertise as the world market leader in injection moulding and form PU, polyester, silicone & Co to fit your innovative ideas. You can count on efficient and clean manufacturing, perfect surface finishes, and smart material combinations, therefore saving weight and costs in a sensible way.

- **combimelt** – combine different materials with competence
- **coinjection** – optimise costs & quality with proficiency
- **foammelt (MuCell®)** – fabricate precise lightweight parts with a micro-foam inner structure
- **foilmelt** – smart surfaces & additional functionality thanks to foils
- **clearmelt** – scratch-resistant premium surface finishes with visual depth effects
- **gasmelt/watermelt** – specific hollow spaces & reduced material use
- **optimelt** – top-quality optical moulded parts
- **organomelt** – lightweight plastic components as strong as steel
- **LIM** – flexible processing of liquid silicone
- **PVC** – economic production with reliable quality
- **duroplast BMC** – thermoset processing of the highest standard
- **HP-RTM** – fibre composite technology with thermosetting systems
- **variomelt** – optimised surfaces thanks to controlled temperature variation
- **clean room technology** – perfect compliance with cleanliness standards in production

## ENGEL combimelt

### Freely combine colours, designs and functional improvements

Combine different materials with competence on the victory: having implemented more than 5,000 combimelt machine solutions, ENGEL is the leader in multiple-component injection moulding. With combimelt you can use injection moulding to manufacture innovative parts moulded from different materials in a single step. The standard clamping unit is complemented by a modular injection unit system. Up to six injection units can be operated simultaneously or sequentially, offering you a machine solution that saves both space and energy.

### The right combination of units for each application

When large shot weights, a small footprint, low system heights or full freedom for automation are called for, ENGEL combimelt is the right solution for every application.

### The right technology for every part

The ENGEL victory optimally supports all multi-colour mould concepts: rotary tables, index plates, slide technology, coinjection or transfer of parts by robot.

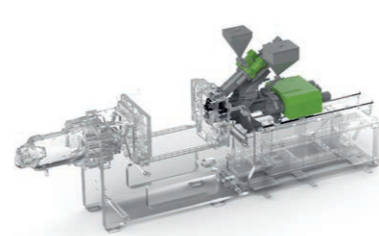
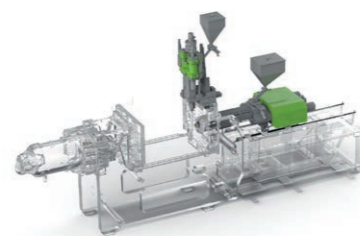
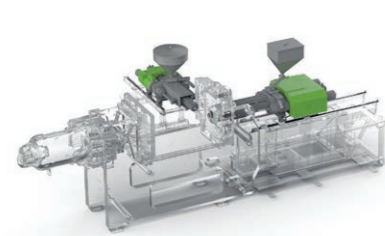
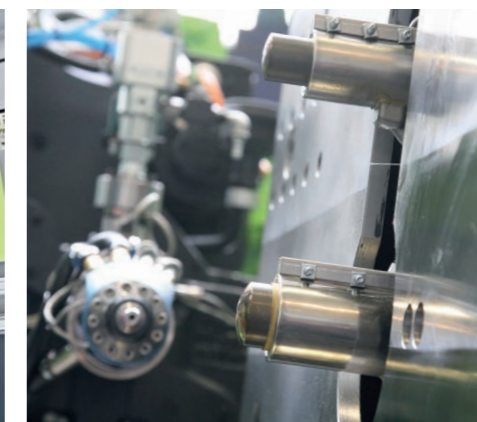
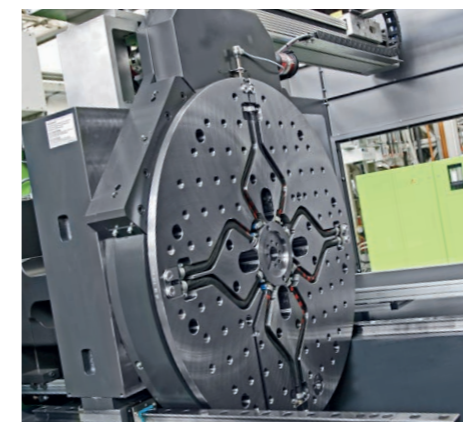

Injection unit in "L" position

Injection unit in "V" position

Injection unit in "W" (piggyback) position

## ENGEL victory – flexible, energy-efficient, reliable

### The versatile ENGEL victory machine series from 280 to 5,000 kN

The proven tie-bar-less technology of the victory, that is, its large mould mounting platens and wide ejection chute, enable the use of a relatively small machine even for large moulds. This means that you only invest in the clamping force you actually require.

ENGEL victory			60			200			330			500			650			860			1060			1560			2460			3660			5160			8160		
			15	18	20	22	25	30	30	35	40	35	40	45	40	45	50	45	50	55	50	55	60	55	60	70	60	70	80	70	80	90	80	90	105	90	105	120
	US tons	kN																																				
ENGEL victory 28	30	280																																				
ENGEL victory 40	45	400																																				
ENGEL victory 50	55	500																																				
ENGEL victory 60	65	600																																				
ENGEL victory 70	75	700																																				
ENGEL victory 80	85	800																																				
ENGEL victory 90	100	900																																				
ENGEL victory 110	120	1 100																																				
ENGEL victory 120	130	1 200																																				
ENGEL victory 140	160	1 400																																				
ENGEL victory 160	180	1 600																																				
ENGEL victory 180	200	1 800																																				
ENGEL victory 200	220	2 000																																				
ENGEL victory 220	240	2 200																																				
ENGEL victory 260	290	2 600																																				
ENGEL victory 300	340	3 000																																				
ENGEL victory 350	400	3 500																																				
ENGEL victory 400	450	4 000																																				
ENGEL victory 450	500	4 500																																				
ENGEL victory 500	560	5 000																																				

■ ENGEL victory tech
 ■ ENGEL victory spex & tech





ENGEL AUSTRIA GmbH | Ludwig-Engel-Straße 1 | 4311 Schwertberg, Austria  
Tel. +43 50 620 0 | Fax +43 50 620 3009 | sales@engel.at | [www.engelglobal.com](http://www.engelglobal.com)

The information, product features and pictures contained in this brochure are intended exclusively as a technical guide. ENGEL is not responsible for any technical changes or print/typographical errors. Reproduction in whole or in part is prohibited without the prior written consent of ENGEL AUSTRIA GmbH.